

Navata Pound Shaper

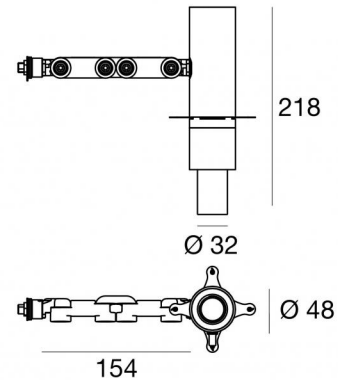

Scheinwerfer | 1 arrayLED 11 W DC 300 mA | CRI 98
76744N66











Technische Daten	
Typ	Oberfläche
Installationsposition	Wand - Decke - Boden
Installationsumgebung	Indoor
Lichtquelle	LED
Circuit structure	arrayLED
Optik	Shaper Short Distance
Light emission direction	frontal
Lampe Nennleistung	11 W DC
Lichtstrom (Lichtquelle)	1182 lm
Eingangsspannungsbereich	300mA
Ähnlichste Farbtemperatur / Tone	4000 K
Farbwiedergabeindex	98 Ra
Gleichstrom/Gleichspannung	CC
Isolierklasse	3
IP	IP20
Glühdrahtprüfung	850°
Direkte Montage auf normal entflammaren Oberflächen	Ja
CE	Ja
Einschließlich Driver	Nein
Leuchte dimmbar	DALI - 1-10V
Schwenkbarkeit	Orientabile
Gesamtwinkel (vertikale Ebene)	90 °
Gesamtwinkel (horizontale Ebene)	360 °
Drehbarkeit	Nein
Begehbarkeit	Nein
Überrollbarkeit	Nein
Einschließlich Kabel	Nein
Harzbeschichtung	Nein
Typ Lichtabstrahlung	Einflammig
Nettogewicht	0.5 Kg
Schutz vor elektrostatischen Entladungen	Nein
Schutz vor Stoßspannungen	Nein

Oberfläche Gehäuse

Material	Stranggepresstes Aluminium EN AB - 46100
Farbe	Sand
Bearbeitungstyp	Pulverbeschichtung

Elektronik

	99734 Multi Power 198~264V AC / 180~275V DC (1 art.)
	99730 DALI - Push and Simply Dim Multi Power 198~264V AC / 180~275V DC (1 art.)
	83054 DALI-2 Controller (1 - 2 art.)
	83055 Multi Power 198~264V AC / 176~264V DC (1 - 2 art.)
	83051 DALI Multi Power 198~264V AC / 176~275V DC (1 art.)
	83052 Multi Power 198~264V AC / 176~264V DC (1 art.)
	83053 Bluetooth Controller (1 art.)
	C-E100006 Multi Power 198~264V AC / 180~275V DC (1 art.)

Navata Pound Shaper



Scheinwerfer | 1 arrayLED 11 W DC 300 mA | CRI 98
76744N66

Single emission projectors for indoor application. The natural white LED light source with a shaper short distance light distribution is composed of 1 arrayed LEDs with CCT of 4000 K and a CRI 98; the source luminous flux is 1182 lm, with a 107.5 lm/W nominal luminous efficacy.

The device body is made of die-cast aluminium en ab - 46100 and features a sand finish, processed by means of powder coating. The ingress protection degree is IP20; the total weight is of 0.5 kg. The power supply driver is not provided and is to be ordered separately.

The total absorbed power is 11 W.

The device features protection class III and can be wall lights, ceiling or floor-mounted.

Compliant with the EN 60598-1 standard and its specific provisions.

Energieeffizienzklasse

ieses Produkt enthält eine Lichtquelle der Energieeffizienzklasse F.

Illuminotechnical Eigenschaften

Light Output Ratio (LOR)	13 %
Lichtstrom (Lichtquelle)	1182 lm
Leuchten Lichtstrom	159 lm
Consumption	11 W
Leuchten Lichtausbeute	14 lm/W
Farbtemperatur	4000 K
Standard Deviation of Colour Matching	2 Step MacAdam
Farbwiedergabeindex	98 Ra
Black Body Locus	On
Standardumgebungstemperatur	-20 / +50°C
Typische Temperatur am Glas	45°C

LED Life / Failure Ratio

L70 B10 C0 252000h (at Tj 65 Ta 25)

UGR

UGR axial	-8.2
UGR transversal	-8.2
X=4H Y=8H	S=0.25H
Reflection factor	70/50/20

OPTICAL

Optik C0/C180	35°
Light distribution simmetry	Symmetrical

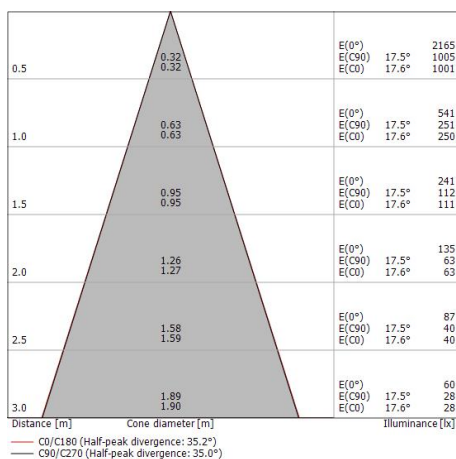
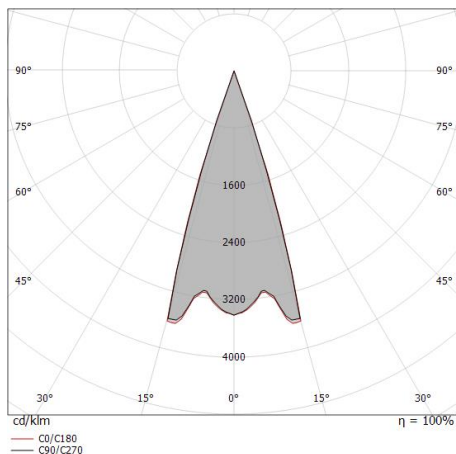

COLOR VECTOR GRAPHIC



Navata Pound Shaper



Navata Pound Shaper | Projectors | Accessories
76744N66

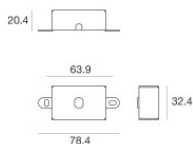

Befestigungsplatte - Basis ohne Netzteil
Material:Eisen, farbe:Sand, bearbeitungstyp :Lackierung.

Code
83242